

Particules et Interactions

Nikola Makovec
Nicolas Arnaud

LAL/IN2P3/CNRS
Université Paris-Sud

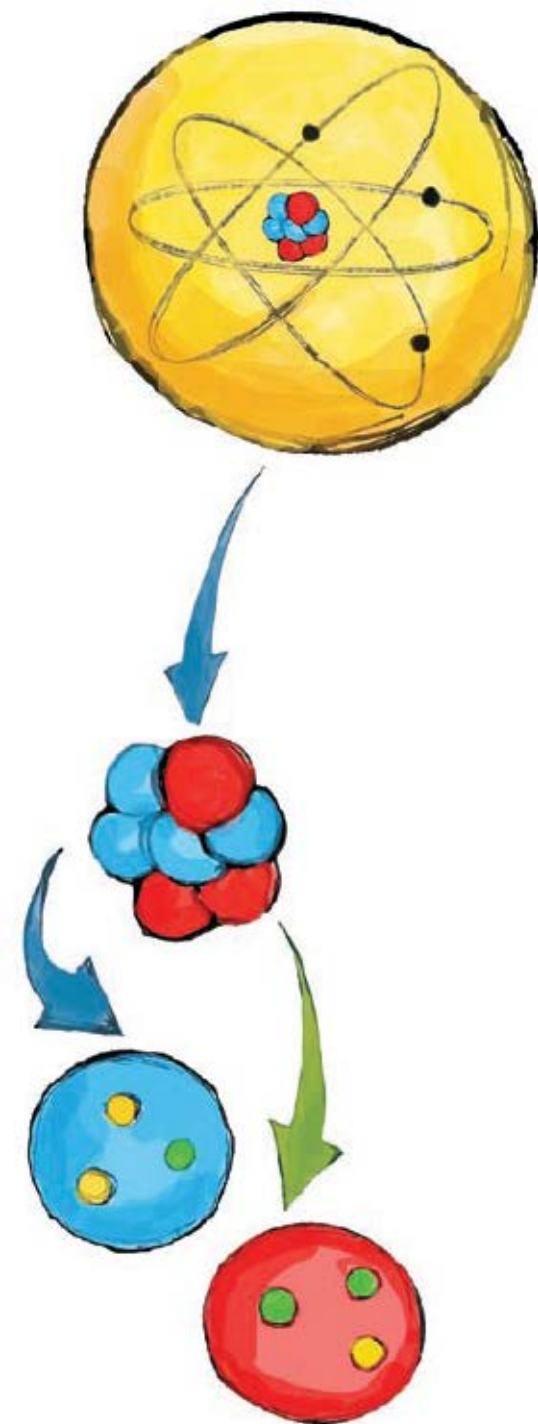

Les particules élémentaires :
des blocs fondamentaux (sans structure interne)
qui constituent l'ensemble de la matière



L'atome

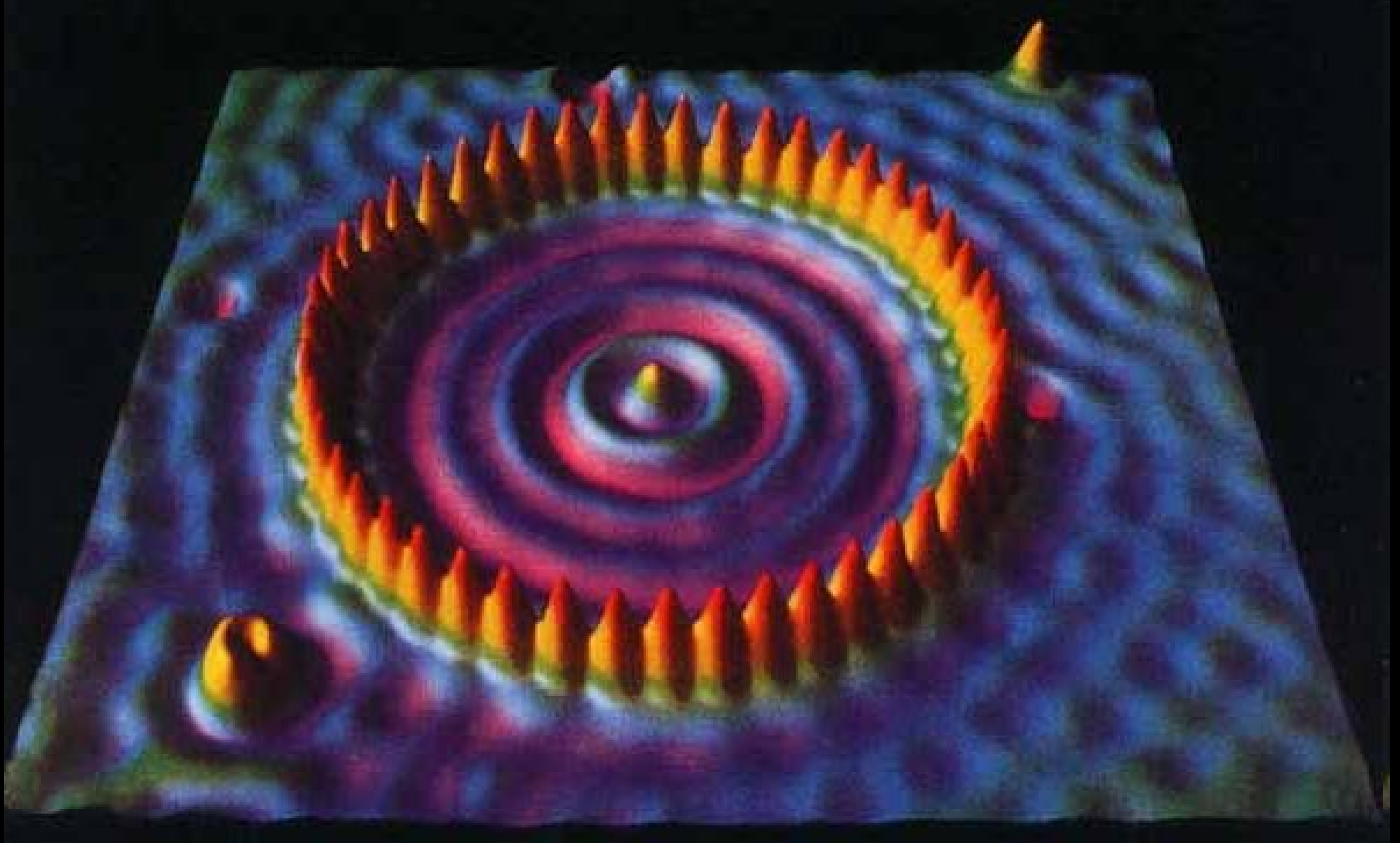

Taille d'un atome: 10^{-10} m = 0.0000000001 m

Plusieurs dizaines de millions de fois plus petit qu'une fourmi

Structure de l'atome

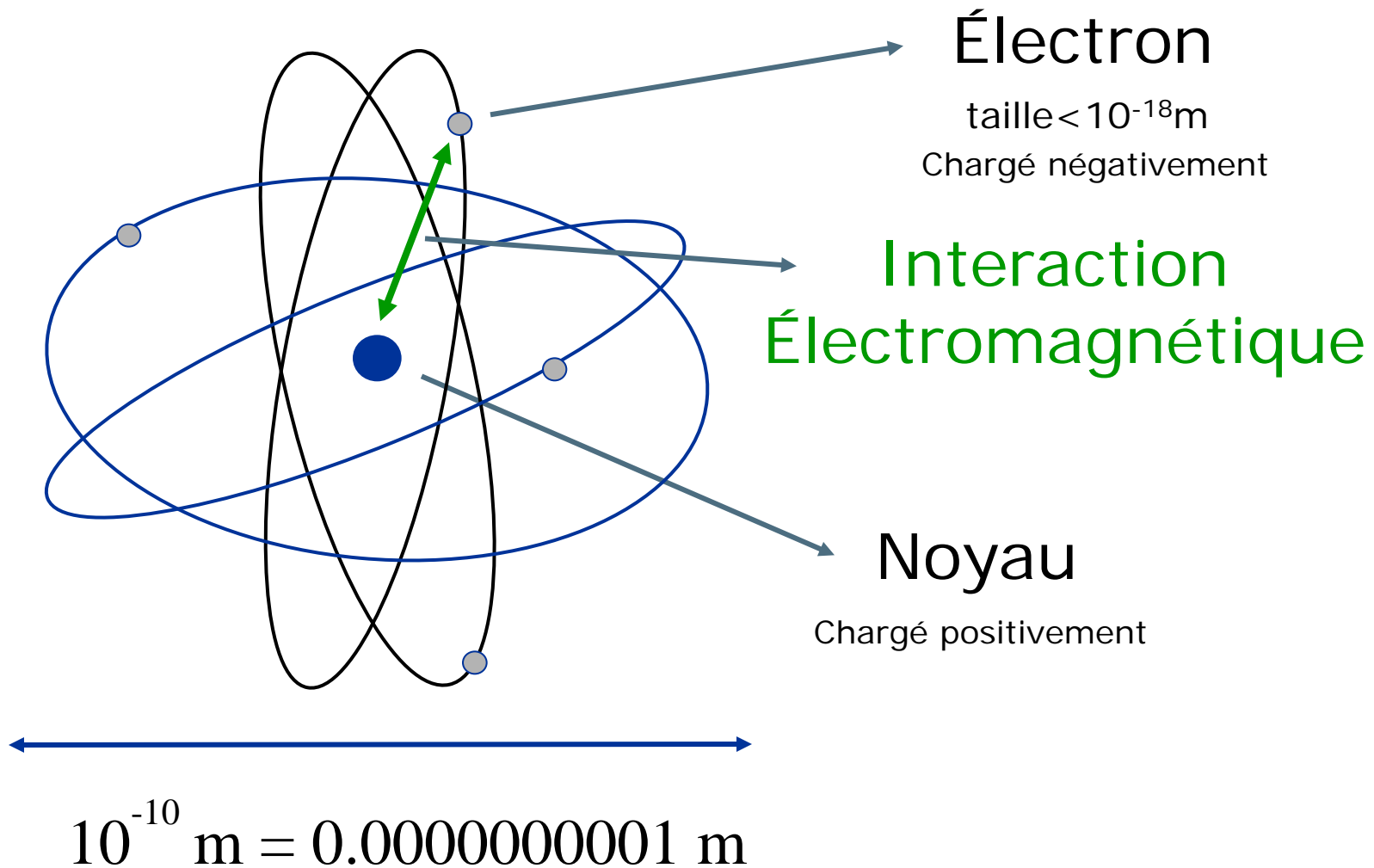

Structure du noyau

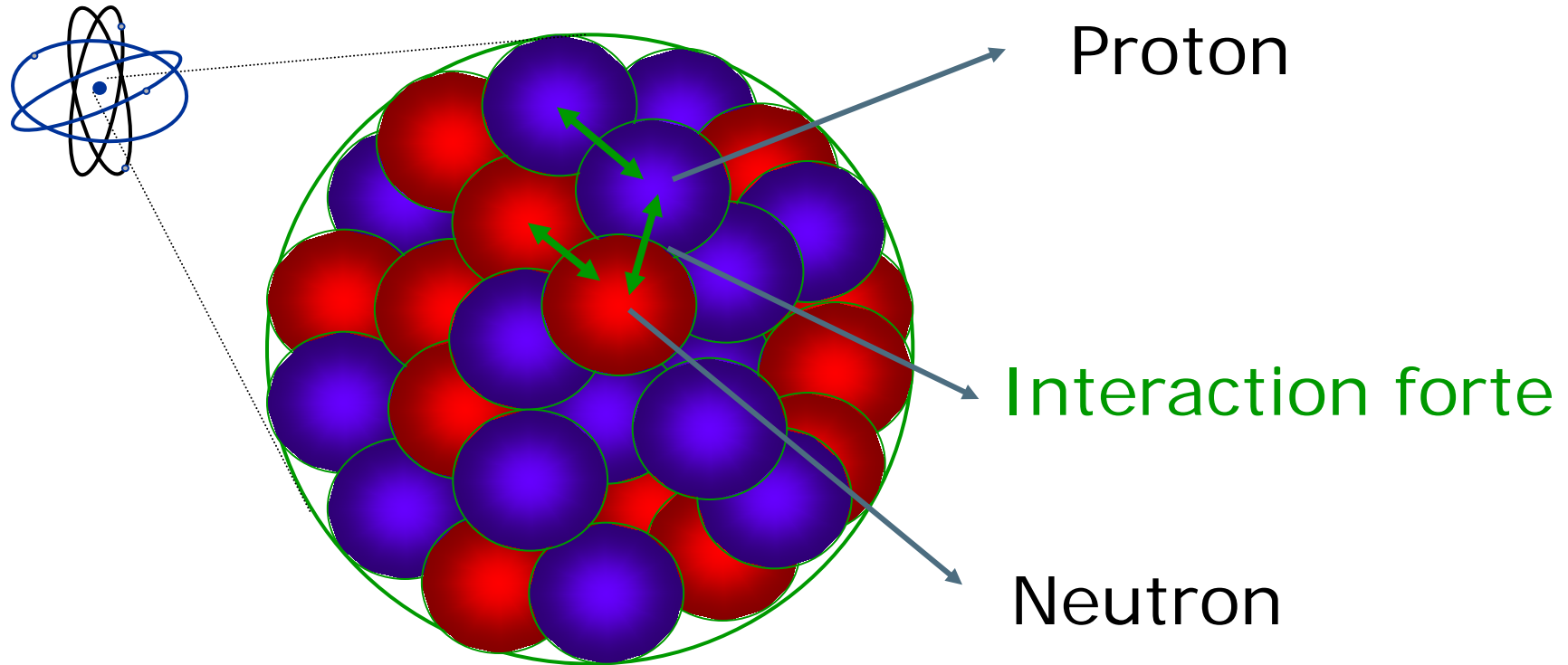

$10^{-14} \text{ m} = 0.0000000000000001 \text{ m}$

Structure des protons et des neutrons

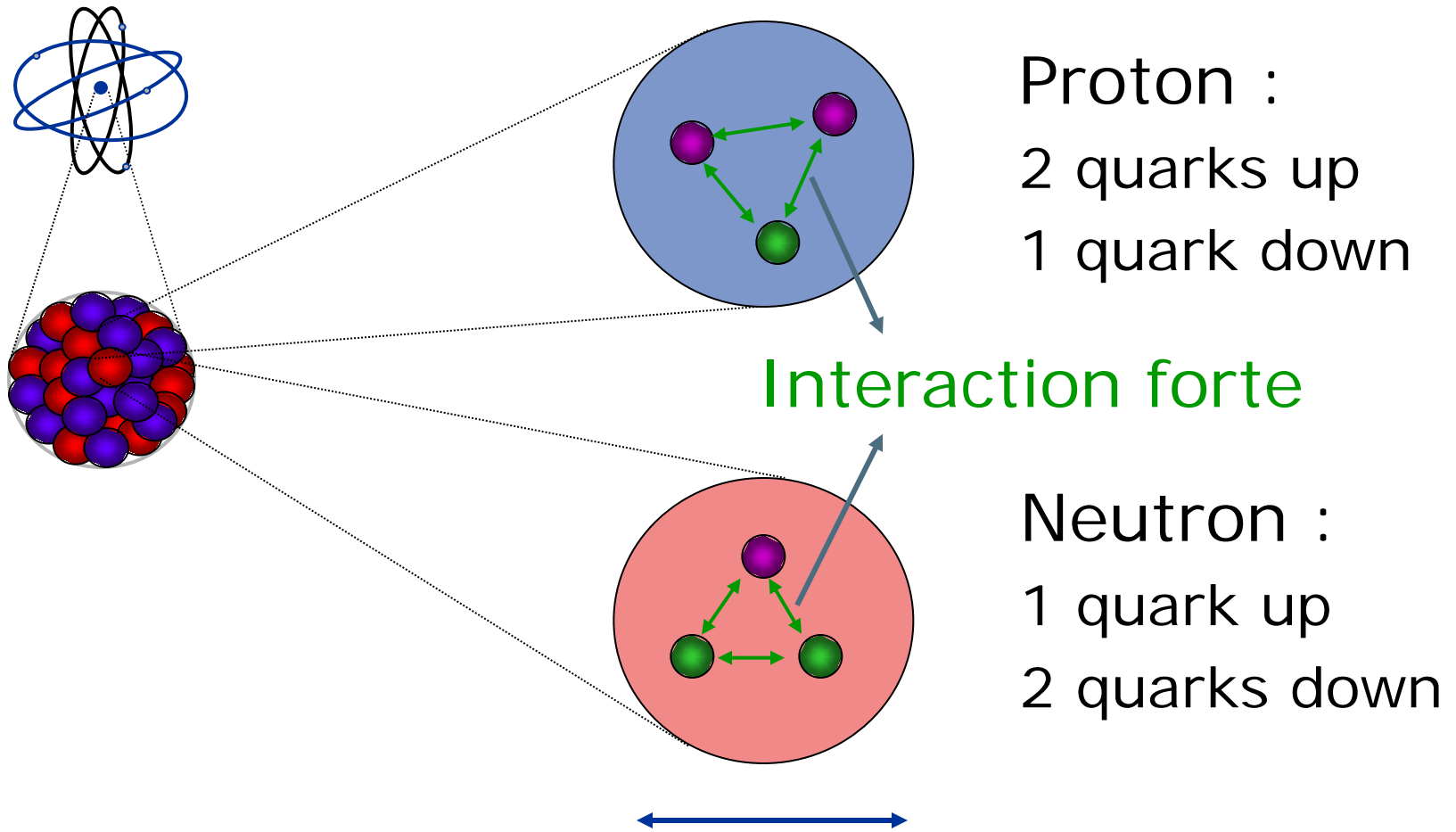

$$10^{-15} \text{ m} = 0.000000000000001 \text{ m}$$

Interagir = échanger une particule

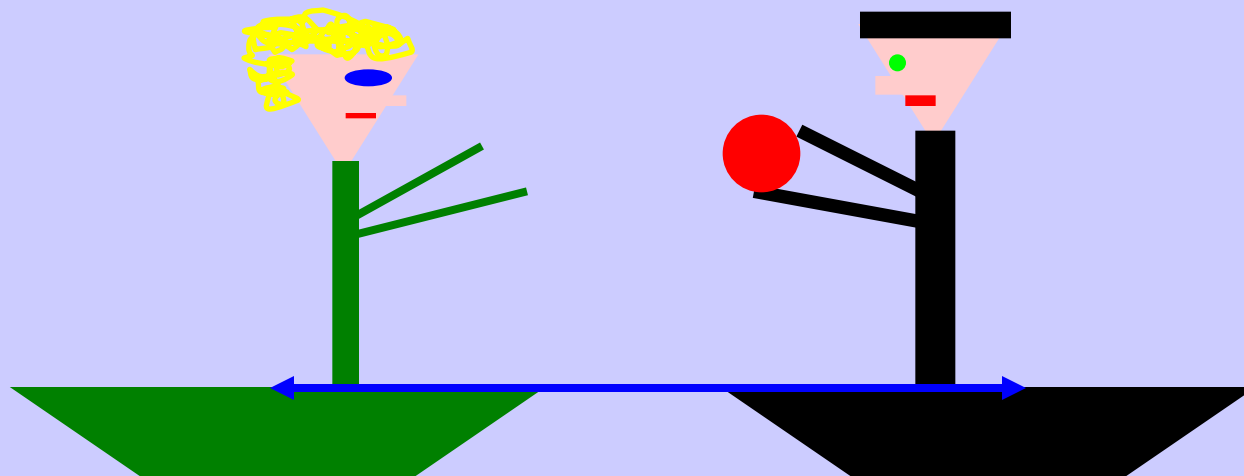
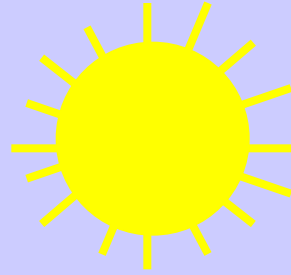

- Les **ballons** sont les **médiateurs** de la force qui écarte les 2 bateaux.
- La **portée** dépend de la **masse** du ballon

Bosons de jauge : médiateurs des interactions fondamentales



L'interaction électromagnétique

Responsable des phénomènes **électriques et magnétiques** :
aimantation, lumière, cohésion des atomes...

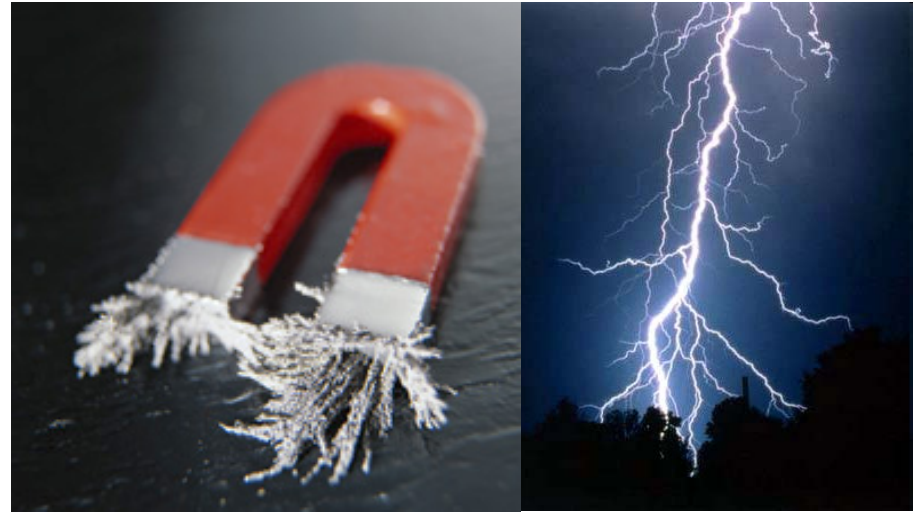

Médiateur : **photon**

$m=0$ (vitesse= c)
portée infinie

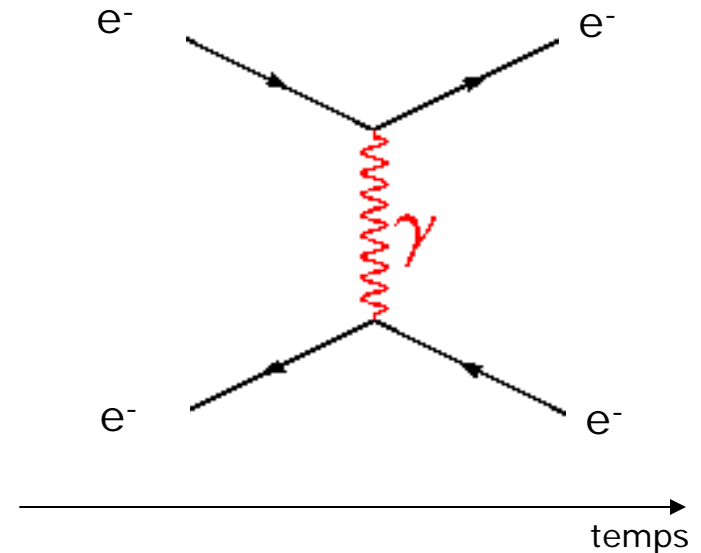

L'interaction forte

Responsable de la stabilité du noyau atomique ainsi que des nucléons (protons et neutrons)

Médiateurs: **8 gluons**

Masses nulles

Portée de l'interaction : 10^{-15} m

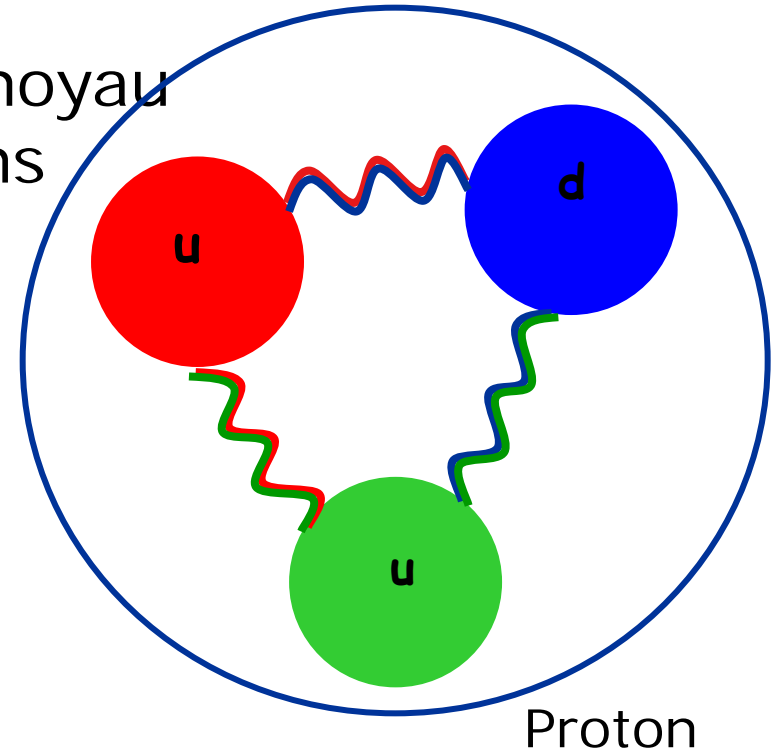

Les quarks (« colorés ») n'existent pas à l'état libre : ils sont toujours confinés dans des hadrons de charge de couleur « blanche » dans lesquels ils sont collés par des gluons

L'interaction faible

- Responsable de la radioactivité β
- Participe aux réactions nucléaires au cœur du Soleil

Médiateurs : W^+, W^- et Z^0

- 100 000 fois plus faible que l'interaction forte
- Portée: 10^{-18} m
 - Expliquée par la grande masse des bosons de jauge de l'interaction faible



Le Modèle Standard

Les quarks

Les leptons

Matière stable

Matière instable

 up	 down	 electron	 neutrino e
 charm	 strange	 muon	 neutrino μ
 top	 beauty	 tau	 neutrino τ

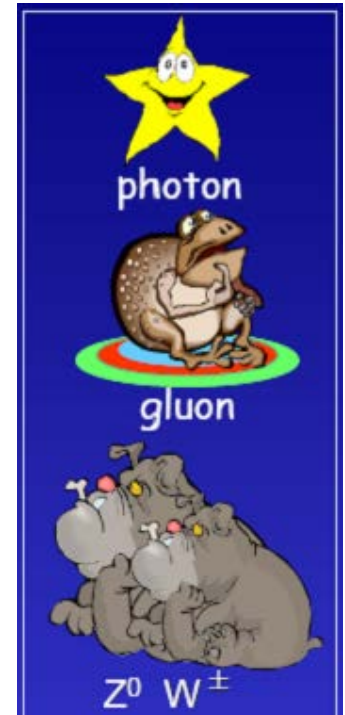

Les fermions

Les bosons

$$\begin{aligned}
\mathcal{L}_{\text{SM}} = & -\frac{1}{2}\partial_\nu g_\mu^a \partial_\nu g_\mu^a - g_s f^{abc} \partial_\mu g_\nu^a g_\mu^b g_\nu^c - \frac{1}{4}g_s^2 f^{abc} f^{ade} g_\mu^b g_\nu^c g_\mu^d g_\nu^e + \frac{1}{2}ig_s^2 (\bar{q}_i^\sigma \gamma^\mu q_j^\sigma) g_\mu^a + \bar{G}^a \partial^2 G^a + g_s f^{abc} \partial_\mu \bar{G}^a G^b g_\mu^c \\
& -\partial_\nu W_\mu^+ \partial_\nu W_\mu^- - M^2 W_\mu^+ W_\mu^- - \frac{1}{2}\partial_\nu Z_\mu^0 \partial_\nu Z_\mu^0 - \frac{1}{2c_w^2} M^2 Z_\mu^0 Z_\mu^0 - \frac{1}{2}\partial_\mu \Lambda_\nu \partial_\mu \Lambda_\nu - \frac{1}{2}\partial_\mu H \partial_\mu H - \frac{1}{2}m_h^2 H^2 - \partial_\mu \phi^+ \partial_\mu \phi^- \\
& -M^2 \phi^+ \phi^- - \frac{1}{2}\partial_\mu \phi^0 \partial_\mu \phi^0 - \frac{1}{2c_w^2} M \phi^0 \phi^0 - \beta_h \left[\frac{2M^2}{g^2} + \frac{2M}{g} H + \frac{1}{2}(H^2 + \phi^0 \phi^0 + 2\phi^+ \phi^-) \right] + \frac{2M^4}{g^2} \alpha_h \\
& -igc_w \left[\partial_\nu Z_\mu^0 (W_\mu^+ W_\nu^- - W_\nu^+ W_\mu^-) - Z_\nu^0 (W_\mu^+ \partial_\nu W_\mu^- - W_\mu^- \partial_\nu W_\mu^+) + Z_\mu^0 (W_\nu^+ \partial_\nu W_\mu^- - W_\nu^- \partial_\nu W_\mu^+) \right] \\
& -igs_w \left[\partial_\nu \Lambda_\mu (W_\mu^+ W_\nu^- - W_\nu^+ W_\mu^-) - \Lambda_\nu (W_\mu^+ \partial_\nu W_\mu^- - W_\mu^- \partial_\nu W_\mu^+) + \Lambda_\mu (W_\nu^+ \partial_\nu W_\mu^- - W_\nu^- \partial_\nu W_\mu^+) \right] \\
& -\frac{1}{2}g^2 W_\mu^+ W_\mu^- W_\nu^+ W_\nu^- + \frac{1}{2}g^2 W_\mu^+ W_\nu^- W_\mu^+ W_\nu^- + g^2 c_w^2 (Z_\mu^0 W_\mu^+ Z_\nu^0 W_\nu^- - Z_\mu^0 Z_\mu^0 W_\nu^+ W_\nu^-) + g^2 s_w^2 (\Lambda_\mu W_\mu^+ \Lambda_\nu W_\nu^- - \Lambda_\mu \Lambda_\mu W_\nu^+ W_\nu^-) \\
& +g^2 s_w c_w [\Lambda_\mu Z_\nu^0 (W_\mu^+ W_\nu^- - W_\nu^+ W_\mu^-) - 2\Lambda_\mu Z_\mu^0 W_\nu^+ W_\nu^-] - g\alpha [H^3 + H\phi^0 \phi^0 + 2H\phi^+ \phi^-] \\
& -\frac{1}{8}g^2 \alpha_h [H^4 + (\phi^0)^4 + 4(\phi^+ \phi^-)^2 + 4(\phi^0)^2 \phi^+ \phi^- + 4H^2 \phi^+ \phi^- + 2(\phi^0)^2 H^2] - gM W_\mu^+ W_\mu^- H - \frac{1}{2}g \frac{M}{c_w^2} Z_\mu^0 Z_\mu^0 H \\
& -\frac{1}{2}ig \left[W_\mu^+ (\phi^0 \partial_\mu \phi^- - \phi^- \partial_\mu \phi^0) - W_\mu^- (\phi^0 \partial_\mu \phi^+ - \phi^+ \partial_\mu \phi^0) \right] + \frac{1}{2}g \left[W_\mu^+ (H \partial_\mu \phi^- - \phi^- \partial_\mu H) - W_\mu^- (H \partial_\mu \phi^+ - \phi^+ \partial_\mu H) \right] \\
& +\frac{1}{2}g \frac{1}{c_w} Z_\mu^0 (H \partial_\mu \phi^0 - \phi^0 \partial_\mu H) - ig \frac{s_w^2}{c_w} M Z_\mu^0 (W_\mu^+ \phi^- - W_\mu^- \phi^+) + igs_w M \Lambda_\mu (W_\mu^+ \phi^- - W_\mu^- \phi^+) - ig \frac{1-2c_w^2}{2c_w} Z_\mu^0 (\phi^+ \partial_\mu \phi^- \\
& -\phi^- \partial_\mu \phi^+) + igs_w \Lambda_\mu (\phi^+ \partial_\mu \phi^- - \phi^- \partial_\mu \phi^+) - \frac{1}{4}g^2 W_\mu^+ W_\mu^- [H^2 + (\phi^0)^2 + 2\phi^+ \phi^-] - \frac{1}{4}g^2 \frac{1}{c_w^2} Z_\mu^0 Z_\mu^0 [H^2 + (\phi^0)^2 \\
& +2(2s_w^2 - 1)^2 \phi^+ \phi^-] - \frac{1}{2}g^2 \frac{s_w^2}{c_w} Z_\mu^0 \phi^0 (W_\mu^+ \phi^- + W_\mu^- \phi^+) - \frac{1}{2}ig^2 \frac{s_w^2}{c_w} Z_\mu^0 H (W_\mu^+ \phi^- - W_\mu^- \phi^+) + \frac{1}{2}g^2 s_w \Lambda_\mu \phi^0 (W_\mu^+ \phi^- + W_\mu^- \phi^+) \\
& +\frac{1}{2}ig^2 s_w \Lambda_\mu H (W_\mu^+ \phi^- - W_\mu^- \phi^+) - g^2 \frac{s_w}{c_w} (2c_w^2 - 1) Z_\mu^0 \Lambda_\mu \phi^+ \phi^- - g^1 s_w^2 \Lambda_\mu \Lambda_\mu \phi^+ \phi^- - \bar{e}^\lambda (\gamma \partial + m_e^\lambda) e^\lambda - \bar{\nu}^\lambda \gamma \partial \nu^\lambda \\
& -\bar{u}_j^\lambda (\gamma \partial + m_u^\lambda) u_j^\lambda - \bar{d}_j^\lambda (\gamma \partial + m_d^\lambda) d_j^\lambda + igs_w \Lambda_\mu [-(\bar{e}^\lambda \gamma^\mu e^\lambda) + \frac{2}{3}(\bar{u}_j^\lambda \gamma^\mu u_j^\lambda) - \frac{1}{3}(\bar{d}_j^\lambda \gamma^\mu d_j^\lambda)] \\
& +\frac{ig}{4c_w} Z_\mu^0 \left[(\bar{\nu}^\lambda \gamma^\mu (1 + \gamma^5) \nu^\lambda) + (\bar{e}^\lambda \gamma^\mu (4s_w^2 - 1 - \gamma^5) e^\lambda) + (\bar{u}_j^\lambda \gamma^\mu (\frac{4}{3}s_w^2 - 1 - \gamma^5) u_j^\lambda) + (\bar{d}_j^\lambda \gamma^\mu (1 - \frac{8}{3}s_w^2 - \gamma^5) d_j^\lambda) \right] \\
& +\frac{ig}{2\sqrt{2}} W_\mu^+ \left[(\bar{\nu}^\lambda \gamma^\mu (1 + \gamma^5) e^\lambda) + (\bar{u}_j^\lambda \gamma^\mu (1 + \gamma^5) C_{\lambda\kappa} d_j^\kappa) \right] + \frac{ig}{2\sqrt{2}} W_\mu^- \left[(\bar{e}^\lambda \gamma^\mu (1 + \gamma^5) \nu^\lambda) + (\bar{d}_j^\kappa C_{\lambda\kappa}^\dagger \gamma^\mu (1 + \gamma^5) u_j^\lambda) \right] \\
& +\frac{ig}{2\sqrt{2}} \frac{m_c^\lambda}{M} \left[-\phi^+ (\bar{\nu}^\lambda (1 - \gamma^5) e^\lambda) + \phi^- (\bar{e}^\lambda (1 + \gamma^5) \nu^\lambda) \right] - \frac{g}{2} \frac{m_c^\lambda}{M} \left[H(\bar{e}^\lambda e^\lambda) + i\phi^0 (\bar{e}^\lambda \gamma^5 e^\lambda) \right] \\
& +\frac{ig}{2M\sqrt{2}} \phi^+ \left[-m_d^\lambda (\bar{u}_j^\lambda C_{\lambda\kappa} (1 - \gamma^5) d_j^\kappa) + m_u^\lambda (\bar{u}_j^\lambda C_{\lambda\kappa} (1 + \gamma^5) d_j^\kappa) \right] + \frac{ig}{2M\sqrt{2}} \phi^- \left[m_d^\lambda (\bar{d}_j^\lambda C_{\lambda\kappa}^\dagger (1 + \gamma^5) u_j^\kappa) - m_u^\lambda (\bar{d}_j^\lambda C_{\lambda\kappa}^\dagger (1 - \gamma^5) u_j^\kappa) \right] \\
& -\frac{g}{2} \frac{m_u^\lambda}{M} H(\bar{u}_j^\lambda u_j^\lambda) - \frac{g}{2} \frac{m_d^\lambda}{M} H(\bar{d}_j^\lambda d_j^\lambda) + \frac{ig}{2} \frac{m_u^\lambda}{M} \phi^0 (\bar{u}_j^\lambda \gamma^5 u_j^\lambda) - \frac{ig}{2} \frac{m_d^\lambda}{M} \phi^0 (\bar{d}_j^\lambda \gamma^5 d_j^\lambda) + \bar{\chi}^+ (\partial^2 - M^2) \chi^+ + \bar{\chi}^- (\partial^2 - M^2) \chi^- \\
& +\bar{\chi}^0 \left(\partial^2 - \frac{M^2}{c_w^2} \right) \chi^0 + \bar{\Upsilon} \partial^2 \Upsilon + igc_w W_\mu^+ (\partial_\mu \bar{\chi}^0 \chi^- - \partial_\mu \bar{\chi}^+ \chi^0) + igs_w W_\mu^+ (\partial_\mu \bar{\Upsilon} \chi^- - \partial_\mu \bar{\chi}^+ \Upsilon) + igc_w W_\mu^- (\partial_\mu \bar{\chi}^- \chi^0 - \partial_\mu \bar{\chi}^0 \chi^+) \\
& +igs_w W_\mu^- (\partial_\mu \bar{\chi}^- \Upsilon - \partial_\mu \bar{\Upsilon} \chi^+) + igc_w Z_\mu^0 (\partial_\mu \bar{\chi}^+ \chi^+ - \partial_\mu \bar{\chi}^- \chi^-) + igs_w \Lambda_\mu (\partial_\mu \bar{\chi}^+ \chi^+ - \partial_\mu \bar{\chi}^- \chi^-) - \frac{1}{2}gM[\bar{\chi}^+ \chi^+ H + \bar{\chi}^- \chi^- H \\
& +\frac{1}{c_w^2} \bar{\chi}^0 \chi^0 H] + \frac{1-2c_w^2}{2c_w} igM[\bar{\chi}^+ \chi^0 \phi^+ - \bar{\chi}^- \chi^0 \phi^-] + \frac{1}{2c_w} igM[\bar{\chi}^0 \chi^- \phi^+ - \bar{\chi}^0 \chi^+ \phi^-] + igMs_w[\bar{\chi}^0 \chi^- \phi^+ - \bar{\chi}^0 \chi^+ \phi^-] \\
& +\frac{1}{2}igM[\bar{\chi}^+ \chi^+ \phi^0 - \bar{\chi}^- \chi^- \phi^0]
\end{aligned}$$

Le Modèle Standard

- Elaboré dans les années 1960-70
- Décrit dans un même cadre les **particules élémentaires** et les **interactions forte et électrofaible**
- Testé expérimentalement avec **grande précision**

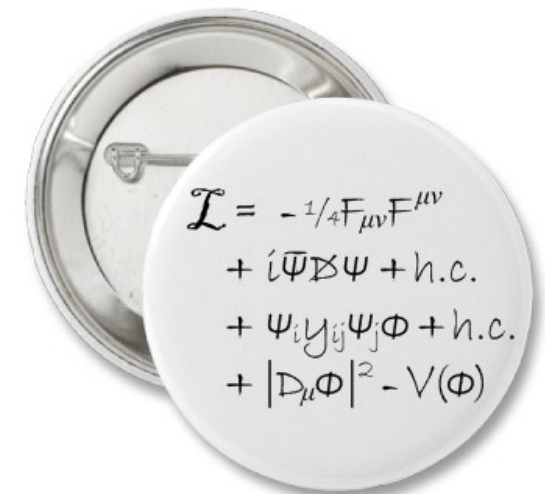
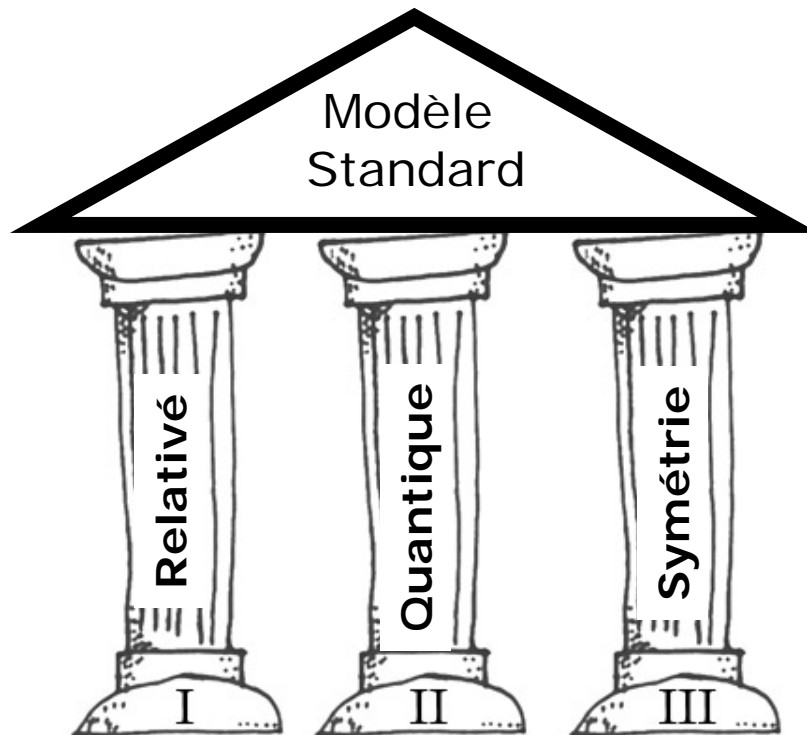

Le mécanisme de Higgs

■ Invariance de jauge

⇒ masse = 0 ($\Leftrightarrow v = c$)

pour les particules élémentaires

⇒ contradiction avec l'expérience

■ Solution = Mécanisme de Higgs

■ L'action du champ de Higgs est équivalente à une sorte de viscosité du vide

■ Proposé en 1964 par:

- P. Higgs
- R. Brout and F. Englert
- G. Guralnik, C. R. Hagen, and T. Kibble

■ La masse quantifie l'inertie d'un corps

■ Plus un objet est massif, plus il est difficile à mettre en mouvement

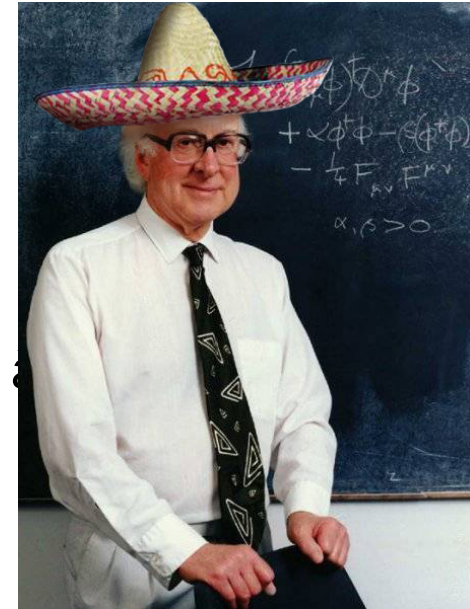

Peter Higgs

Le mécanisme de Higgs

Le photon: masse nulle



L'électron: petite masse



Le boson Z: grande masse

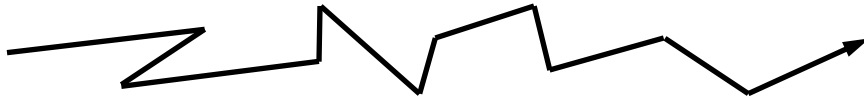

Plus difficile à mettre en mvmt

L'action du champ de Higgs est équivalent à une sorte de viscosité du vide

Le boson de Higgs

Boson de Higgs = quanta du champ de Higgs



Le boson de Higgs joue un rôle central dans le mécanisme qui explique la masse des particules élémentaires

4 Juillet 2012

Libération

17



Le canal $H \rightarrow \gamma\gamma$

$$m_{\gamma\gamma} = \sqrt{\frac{(E_1 + E_2)^2}{c^2} - \left(\frac{\vec{p}_1 + \vec{p}_2}{c}\right)^2}$$

Higgs ($m_H = 125$ GeV)

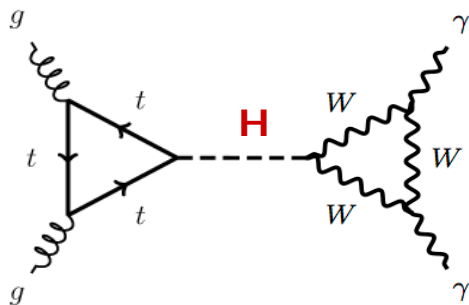
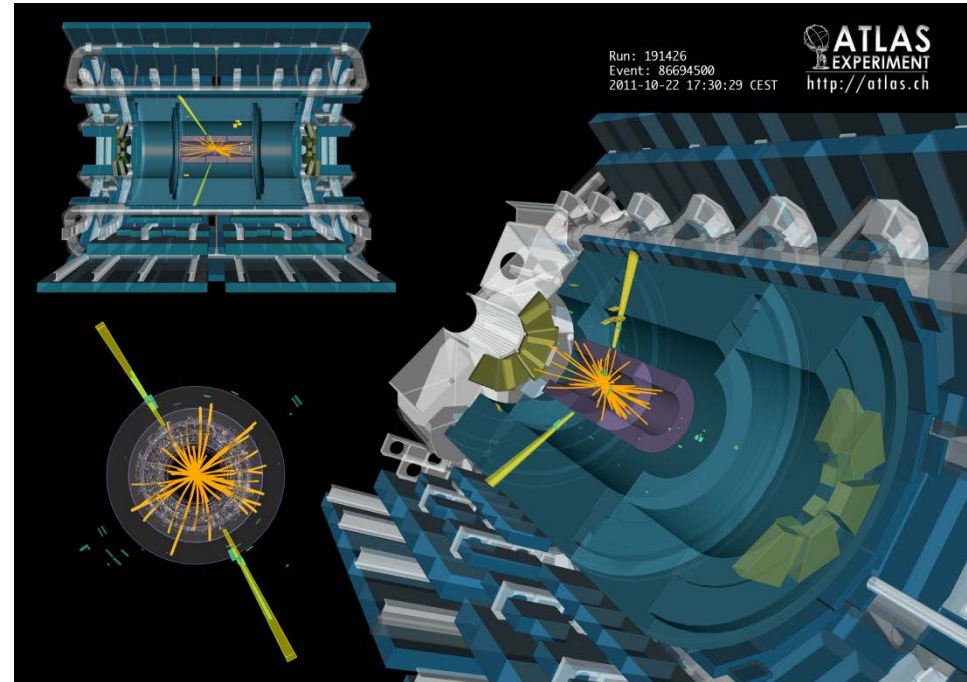
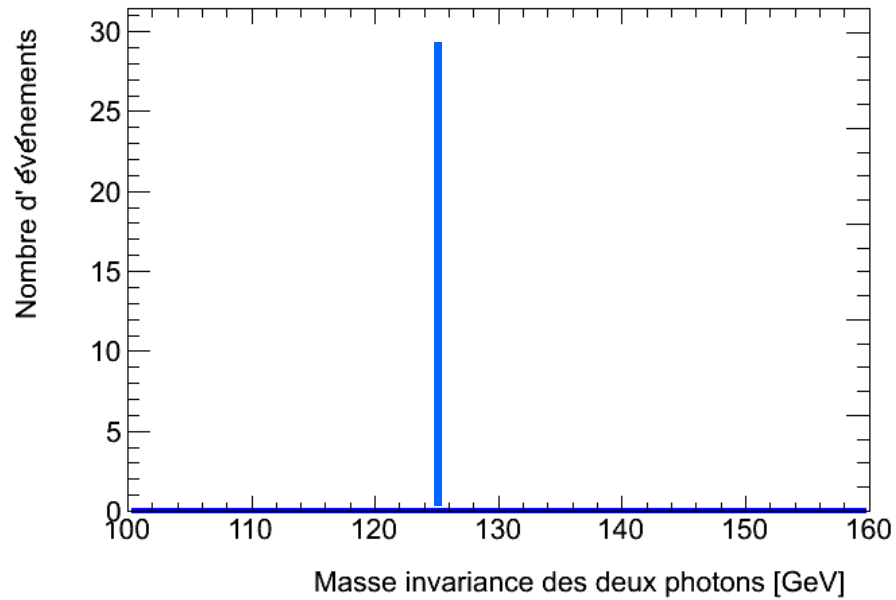

Le canal $H \rightarrow \gamma\gamma$

$$m_{\gamma\gamma} = \sqrt{\frac{(E_1 + E_2)^2}{c^2} - \left(\frac{\vec{p}_1 + \vec{p}_2}{c}\right)^2}$$

Higgs ($m_H = 125$ GeV)

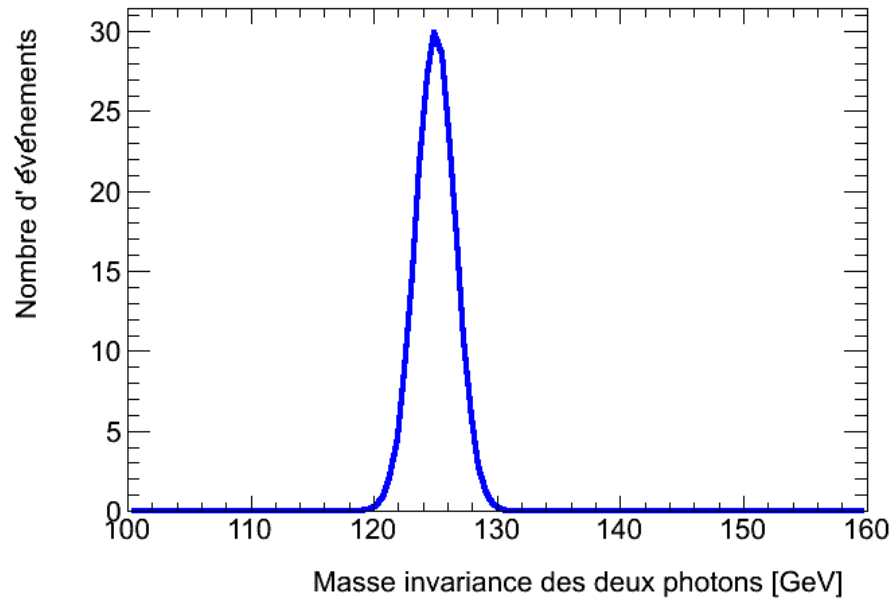

Résolution
du
détecteur

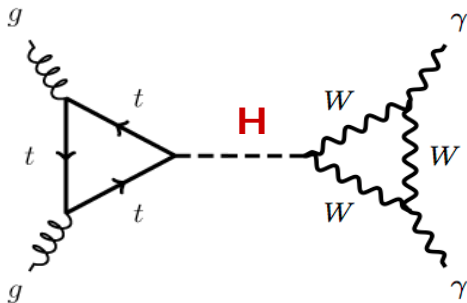

Le canal $H \rightarrow \gamma\gamma$

$$m_{\gamma\gamma} = \sqrt{\frac{(E_1 + E_2)^2}{c^2} - \left(\frac{\vec{p}_1 + \vec{p}_2}{c}\right)^2}$$

Higgs ($m_H = 125$ GeV)

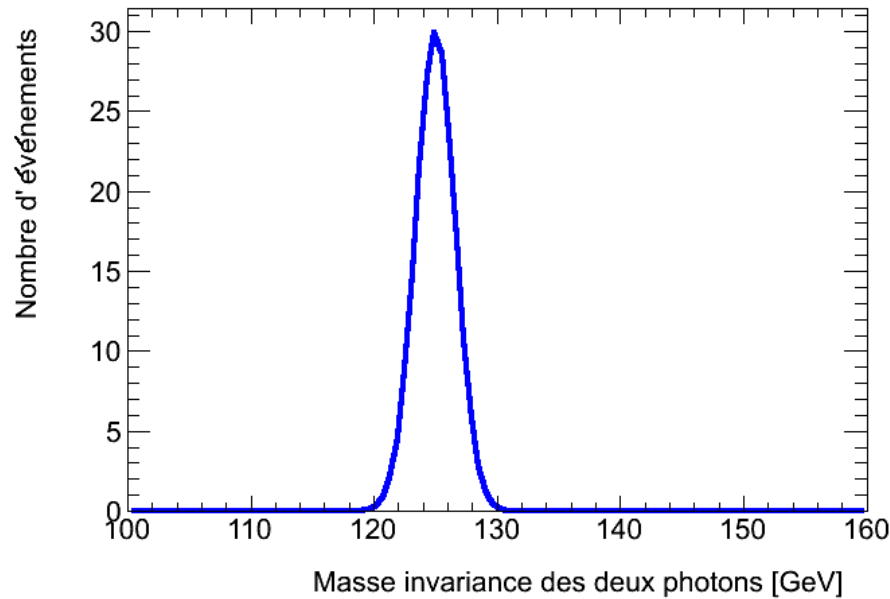

Bruit de fond

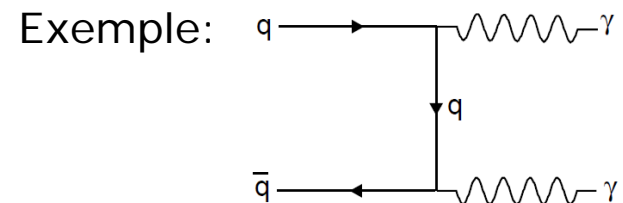
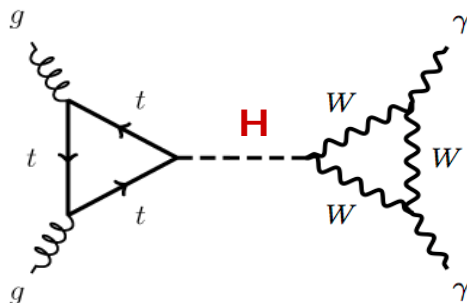
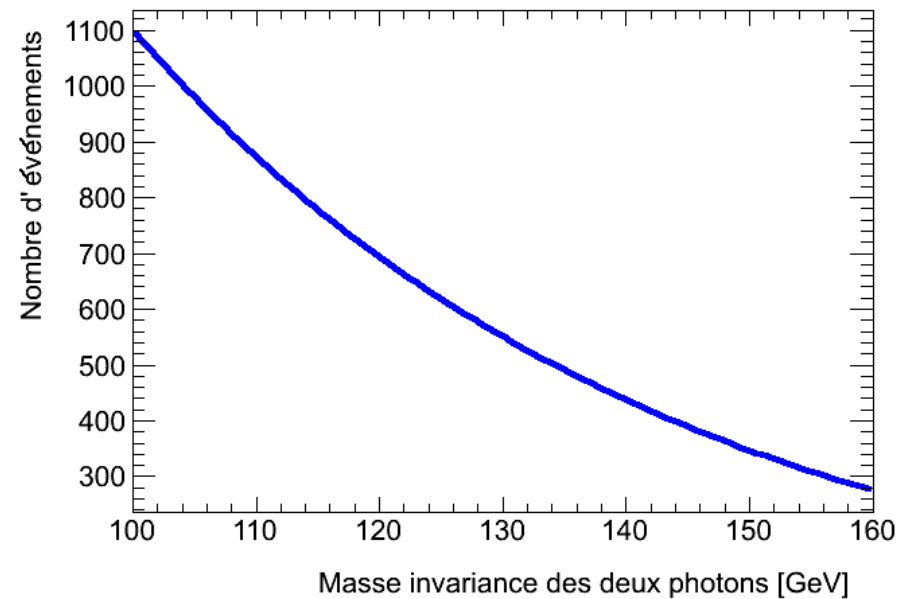

Le canal $H \rightarrow \gamma\gamma$: simulation

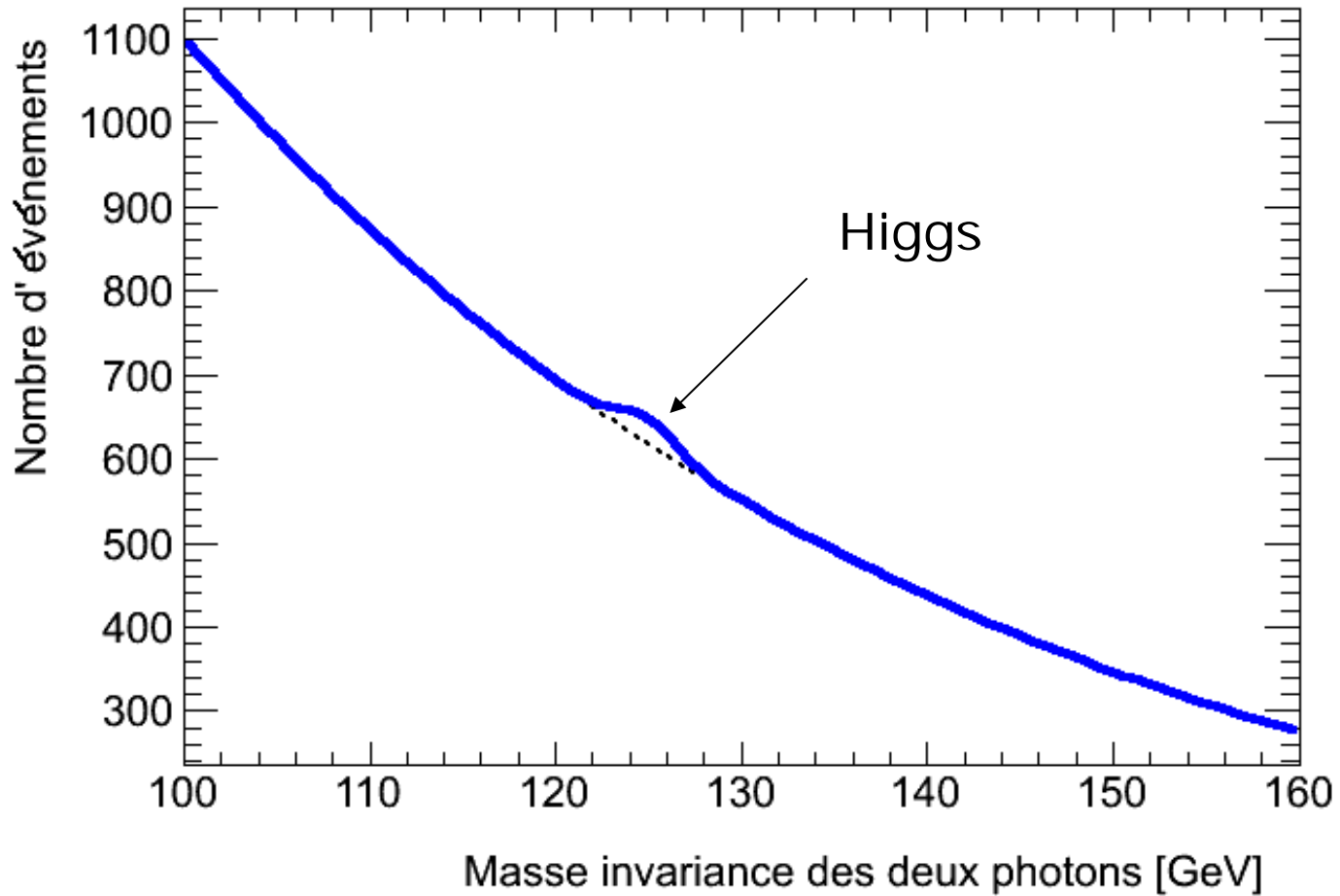

Bosse = signature du boson de Higgs

Découverte d'une nouvelle particule au CERN

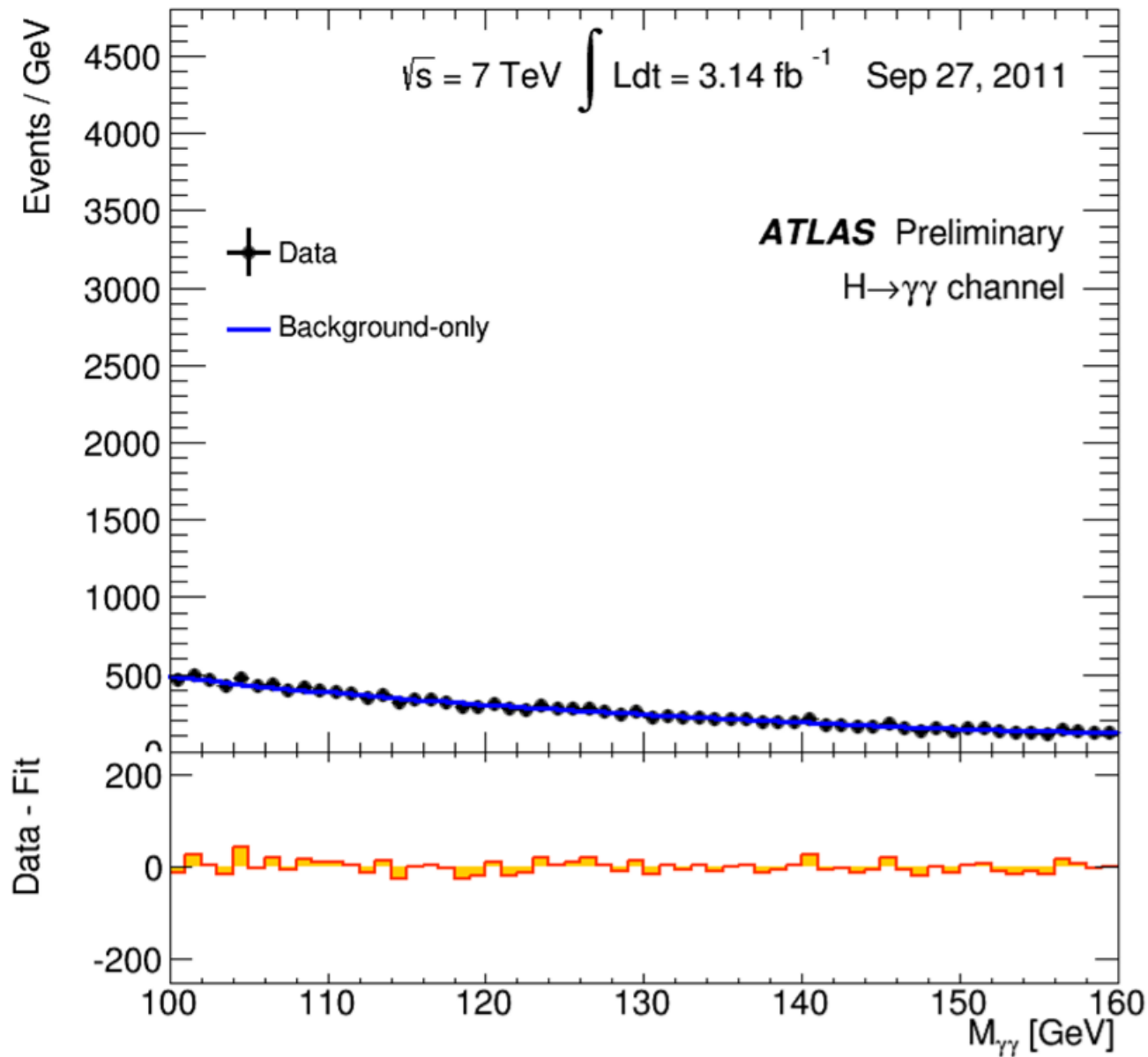

Découverte d'une nouvelle particule au CERN

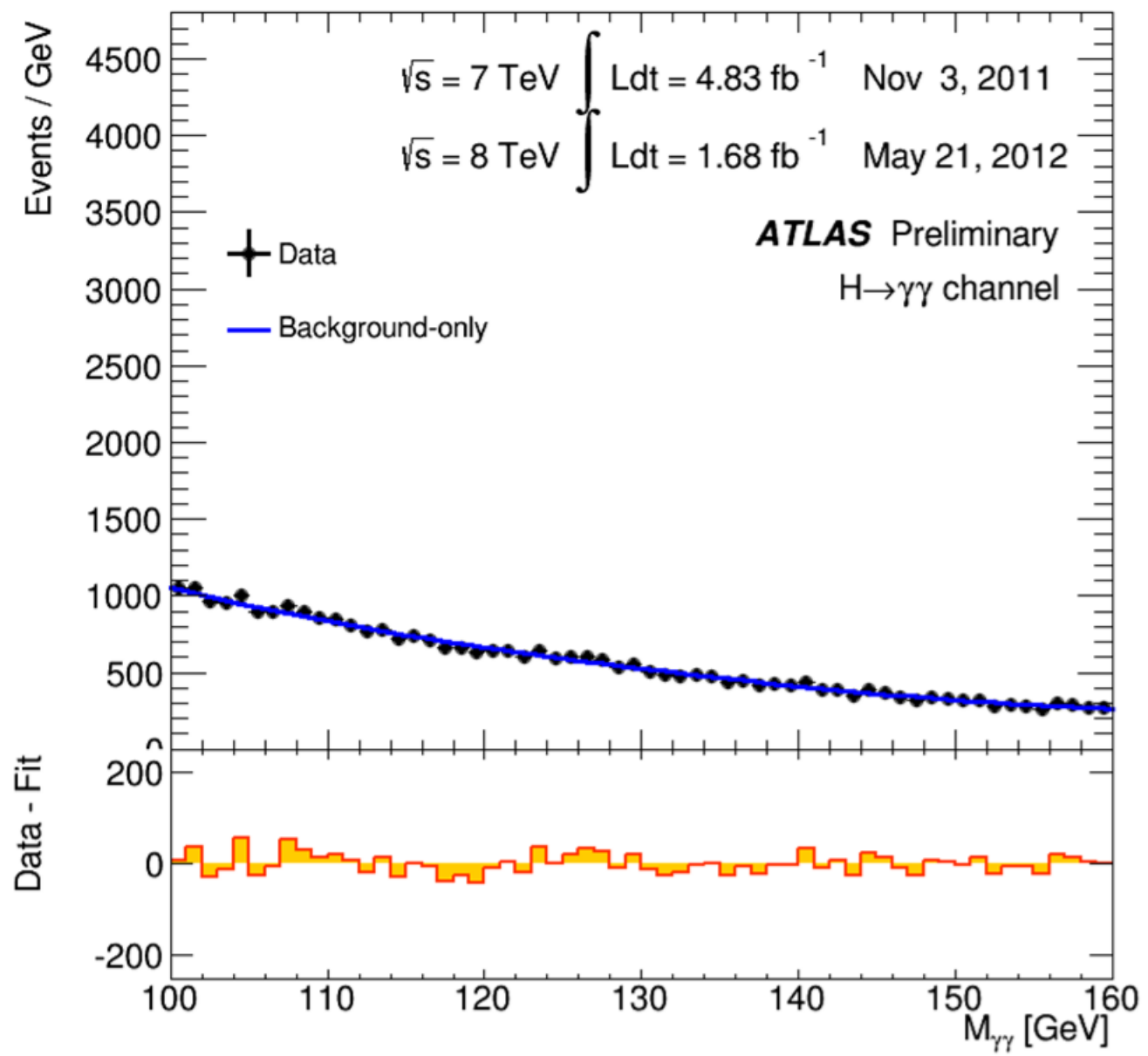

Découverte d'une nouvelle particule au CERN

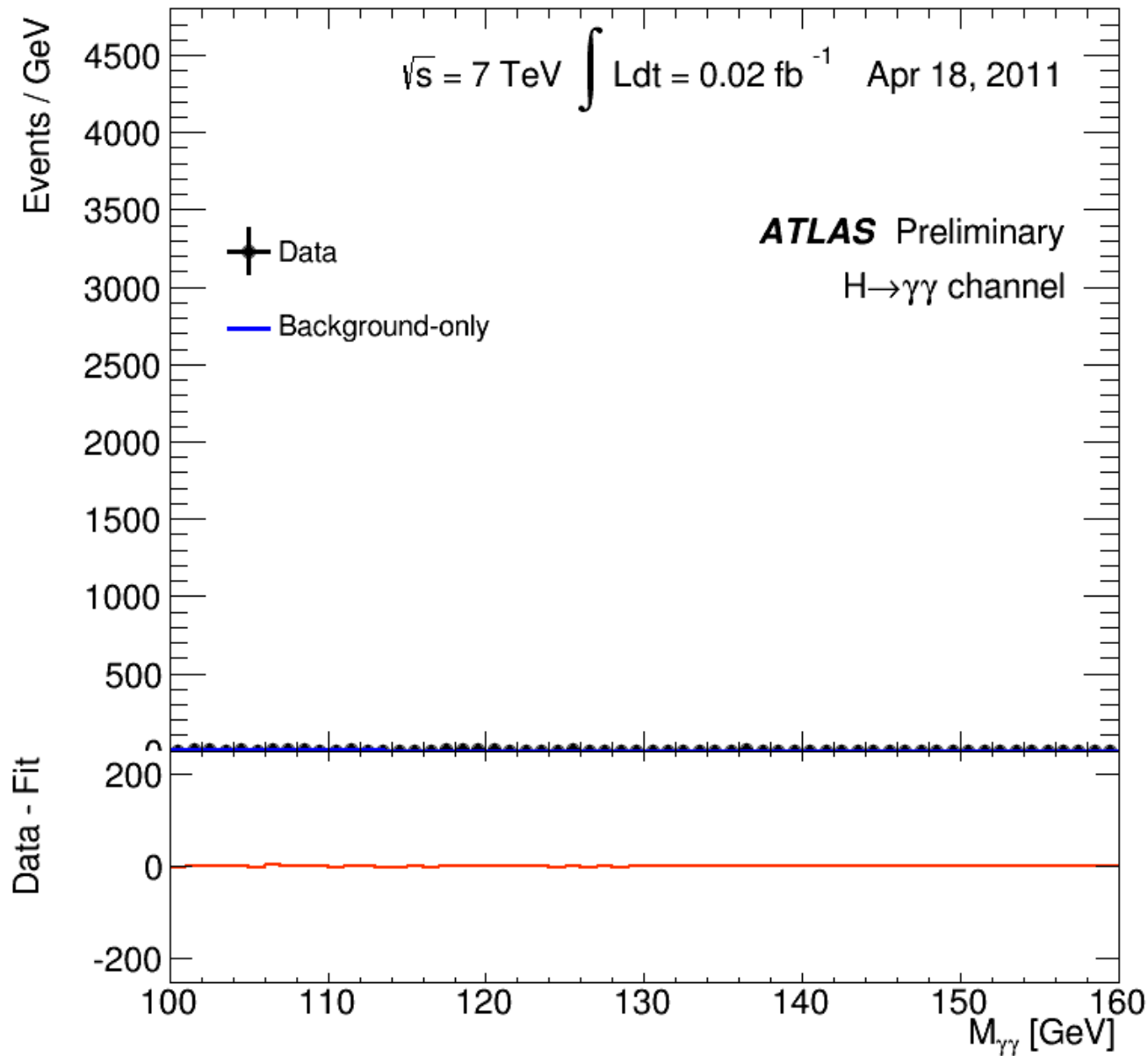

Découverte d'une nouvelle particule au CERN

- Une nouvelle particule a été découverte
 - Dans plusieurs canaux: 2γ , 4 leptons, $2W$
 - Indépendamment par ATLAS et CMS
 - Masse: $125 \text{ GeV}/c^2$ ($133 \times m_{\text{proton}}$)
 - C'est un boson
- Mais est-ce le boson de Higgs du MS?
 - Nombre quantique? (~carte d'identité)
 - Couplage aux autres particules?
- Prix Nobel 2013 pour P.Higgs et F.Englert
- Est-ce une particule élémentaire?
- Y a-t-il d'autres bosons de Higgs?

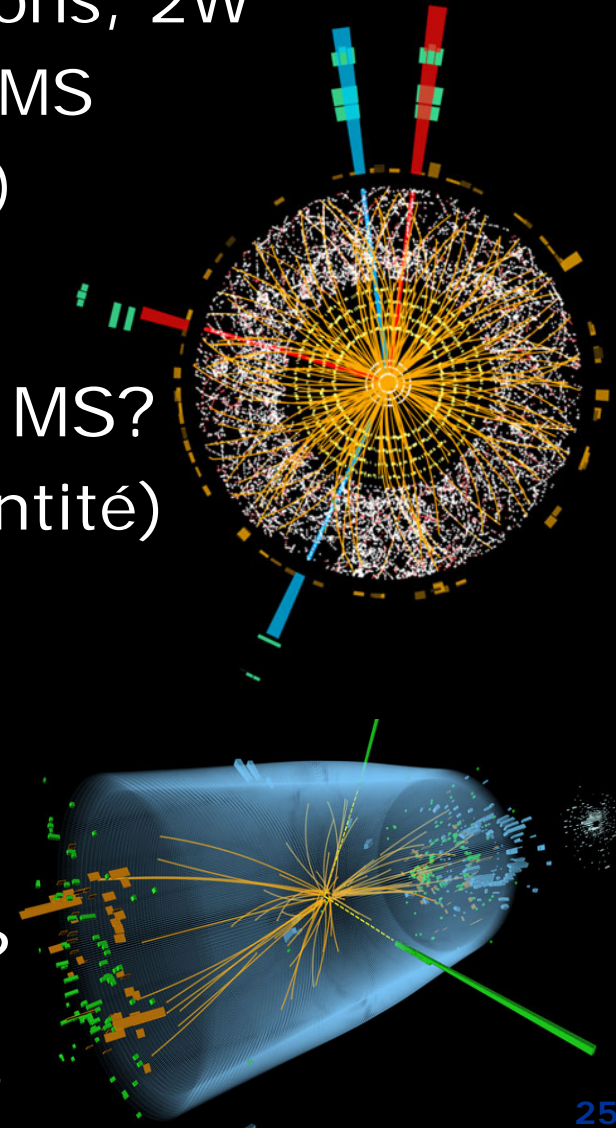

Résumé

■ Particules de matières: **fermions**

- Particules stables et « utiles » pour bâtir l'univers:
 - électron, quark up et quark down
 - proton = 2 quarks u et un quark d
- Particules instables:
 - muon, tau, quark étrange,...
- A chaque particule est associée une antiparticule

■ Particules d'interactions: **bosons**

- Photon: interaction électromagnétique
- Boson Z/W: interaction faible
- Gluon: interaction forte

■ Le **Modèle Standard** est le cadre théorique qui permet de décrire les particules et leurs interactions

- La **masse des particules élémentaires** proviendrait de l'interaction avec le **champ de Higgs**

■ Une nouvelle particule a été découverte au CERN

- Est-ce bien le **boson de Higgs** du Modèle Standard?

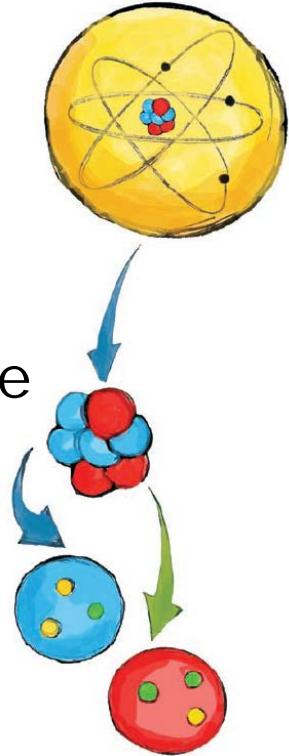

Matière

Quarks

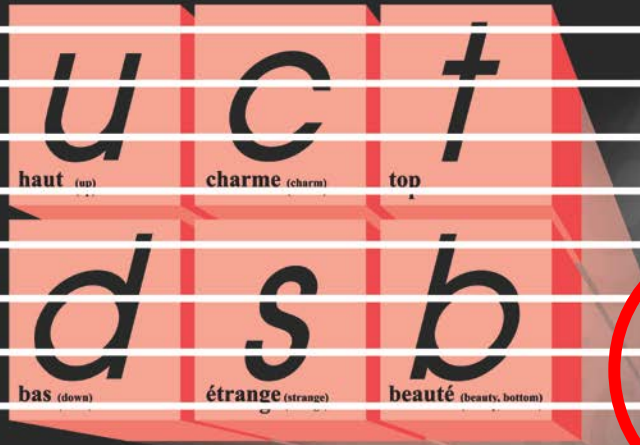

Forces

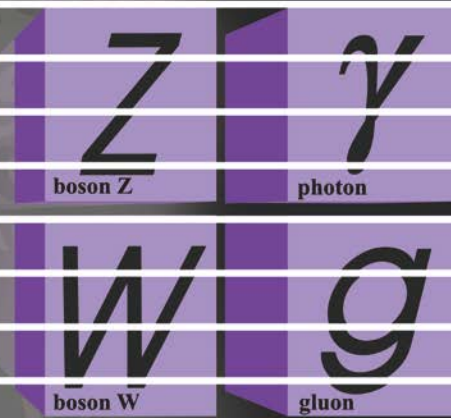

5% Matière Visible



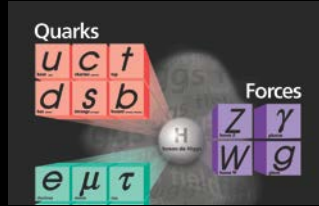

Le contenu énergétique de l'Univers

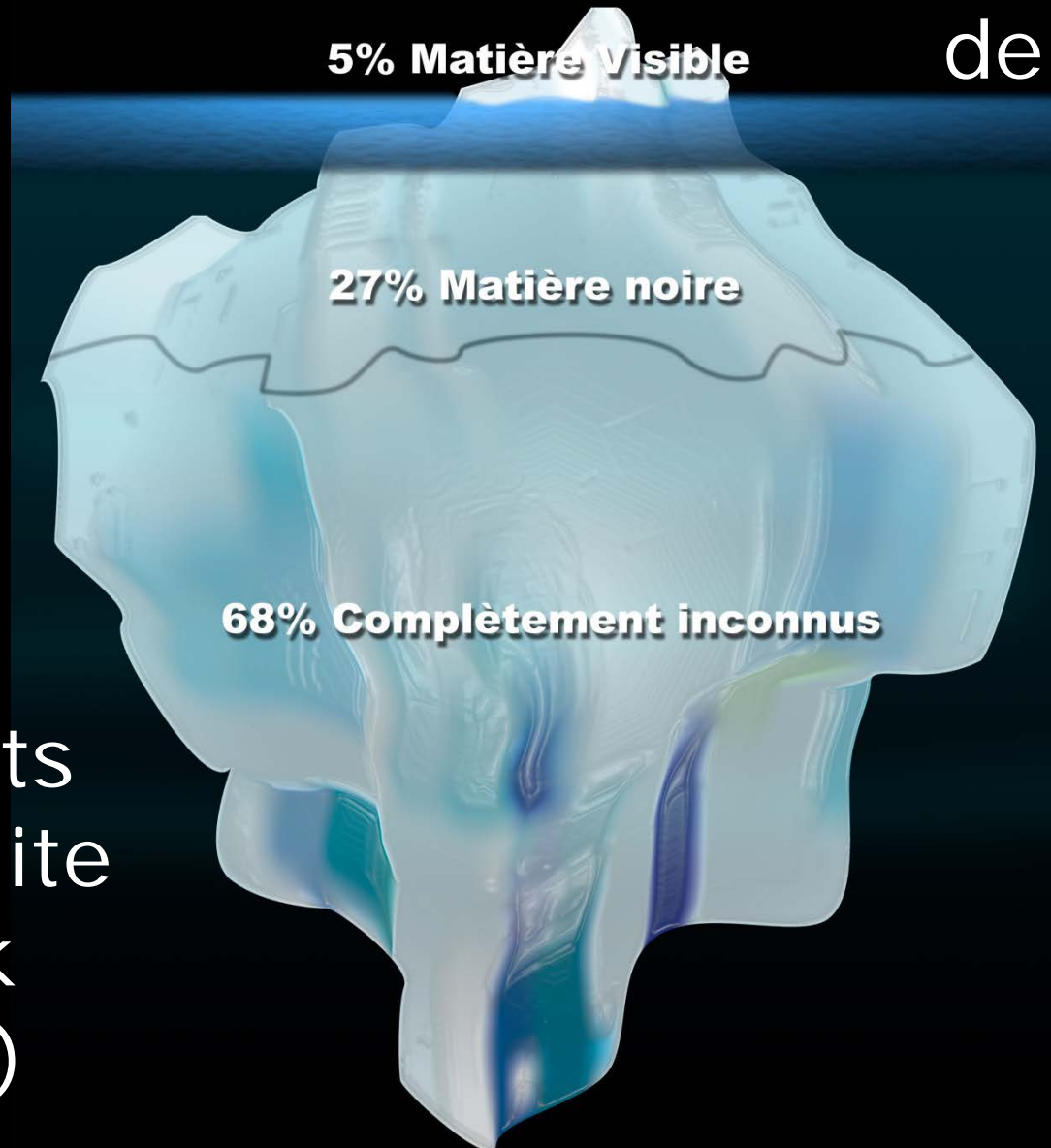

Résultats
du satellite
Planck
(2013)